



SOT-23 Plastic-Encapsulate Transistors

S9015LT1 TRANSISTOR (PNP)

FEATURES

Power dissipation

$$P_{CM}: 0.2 \text{ W (Tamb=25}^\circ\text{C)}$$

Collector current

$$I_{CM}: -0.1 \text{ A}$$

Collector-base voltage

$$V_{(BR)CBO}: -50 \text{ V}$$

Operating and storage junction temperature range

$$T_J, T_{stg}: -55^\circ\text{C to } +150^\circ\text{C}$$

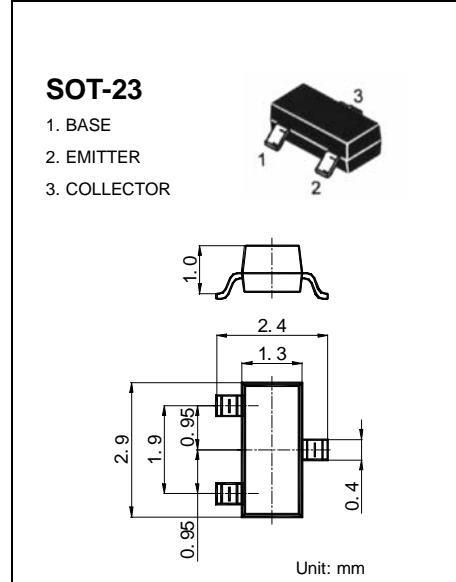

ELECTRICAL CHARACTERISTICS (Tamb=25°C unless otherwise specified)

Parameter	Symbol	Test conditions	MIN	TYP	MAX	UNIT
Collector-base breakdown voltage	$V_{(BR)CBO}$	$I_C = -100\mu\text{A}, I_E = 0$	-50			V
Collector-emitter breakdown voltage	$V_{(BR)CEO}$	$I_C = -0.1\text{mA}, I_B = 0$	-45			V
Emitter-base breakdown voltage	$V_{(BR)EBO}$	$I_E = -100\mu\text{A}, I_C = 0$	-5			V
Collector cut-off current	I_{CBO}	$V_{CB} = -50\text{V}, I_E = 0$			-0.1	μA
Emitter cut-off current	I_{EBO}	$V_{EB} = -5\text{V}, I_C = 0$			-0.1	μA
DC current gain	$h_{FE(1)}$	$V_{CE} = -5\text{V}, I_C = -1\text{mA}$	200		1000	
Collector-emitter saturation voltage	$V_{CE(sat)}$	$I_C = -100\text{mA}, I_B = -10\text{mA}$			-0.3	V
Base-emitter saturation voltage	$V_{BE(sat)}$	$I_C = -100\text{mA}, I_B = -10\text{mA}$			-1	V
Transition frequency	f_T	$V_{CE} = -5\text{V}, I_C = -10\text{mA}$ $f = 30\text{MHz}$	150			MHz

CLASSIFICATION OF $h_{FE(1)}$

Rank	L	H
Range	200-400	400-600

DEVICE MARKING	S9015LT1=M6
----------------	-------------

Typical Characteristics

S9015LT1

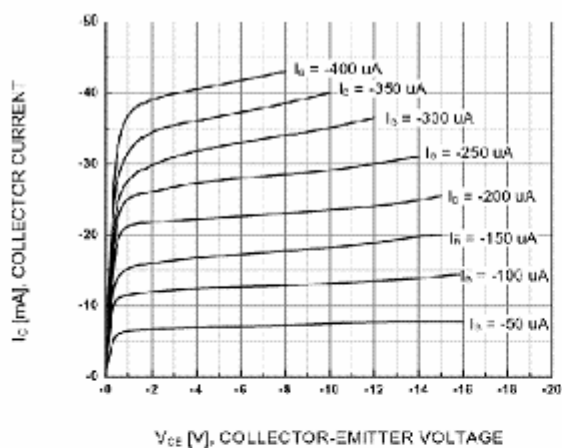

Figure 1. Static Characteristic

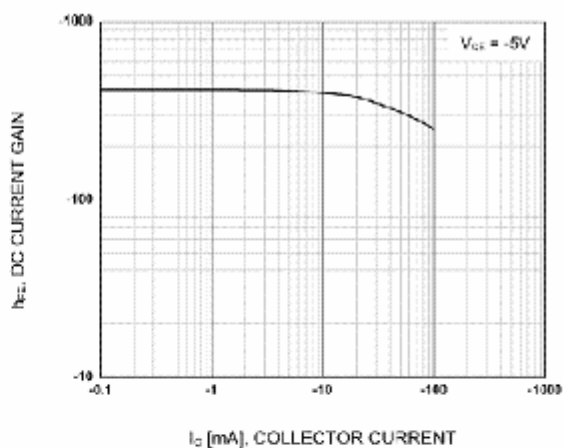

Figure 2. DC current Gain

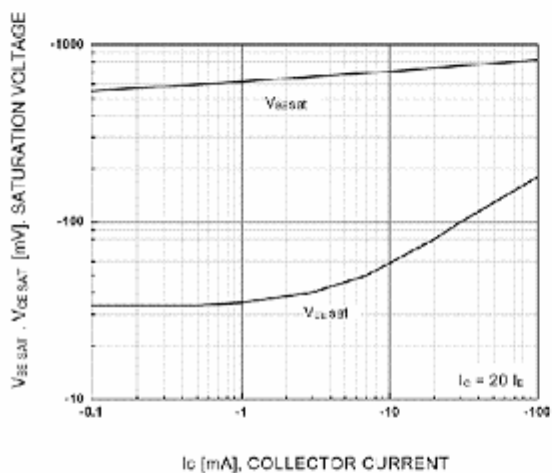

Figure 3. Base-Emitter Saturation Voltage
Collector-Emitter Saturation Voltage

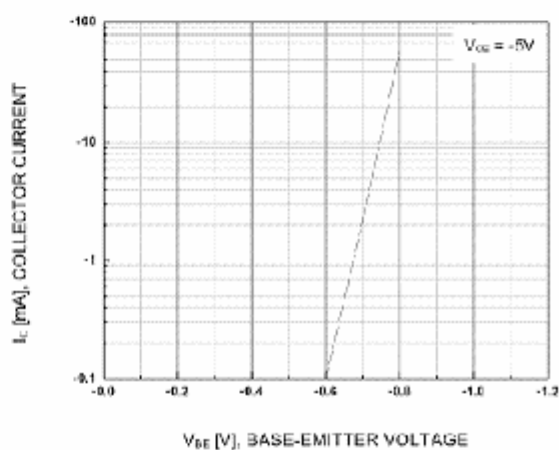

Figure 4. Base-Emitter On Voltage

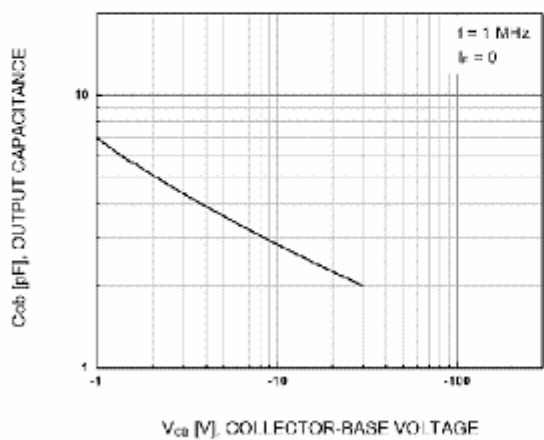

Figure 5. Collector Output Capacitance

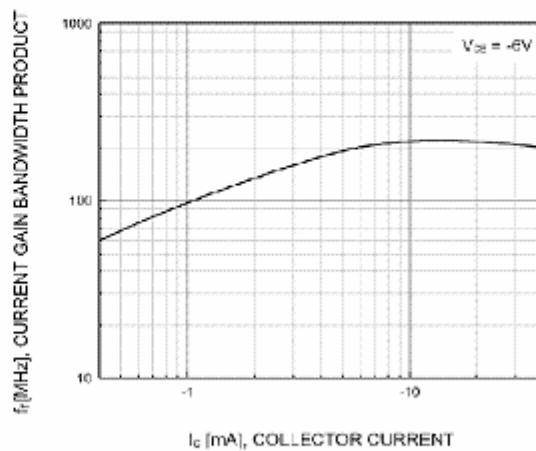

Figure 6. Current Gain Bandwidth Product